



McElroy Manufacturing, Inc.
The leader by design.
Tulsa, Oklahoma U.S.A.

DRAWN: RWH CHECK: ERA APPRVD: BWJ DATE: 7/18/17 SHT No: 1 REV No: A PART No: TP-1300

METRIC TEST CAP ASSEMBLY

NOTE: THIS DRAWING AND THE INFORMATION CONTAINED THEREIN IS THE CONFIDENTIAL AND PROPRIETARY PROPERTY OF McElroy Manufacturing, Inc. THE DRAWING IS NOT TO BE REPRODUCED IN ANY MANNER, SUBMITTED TO OUTSIDE PARTIES FOR EXAMINATION, OR USED DIRECTLY OR INDIRECTLY FOR THE PURPOSES OTHER THAN THOSE FOR WHICH IT WAS FURNISHED WITHOUT WRITTEN PERMISSION OF McElroy Manufacturing, Inc.

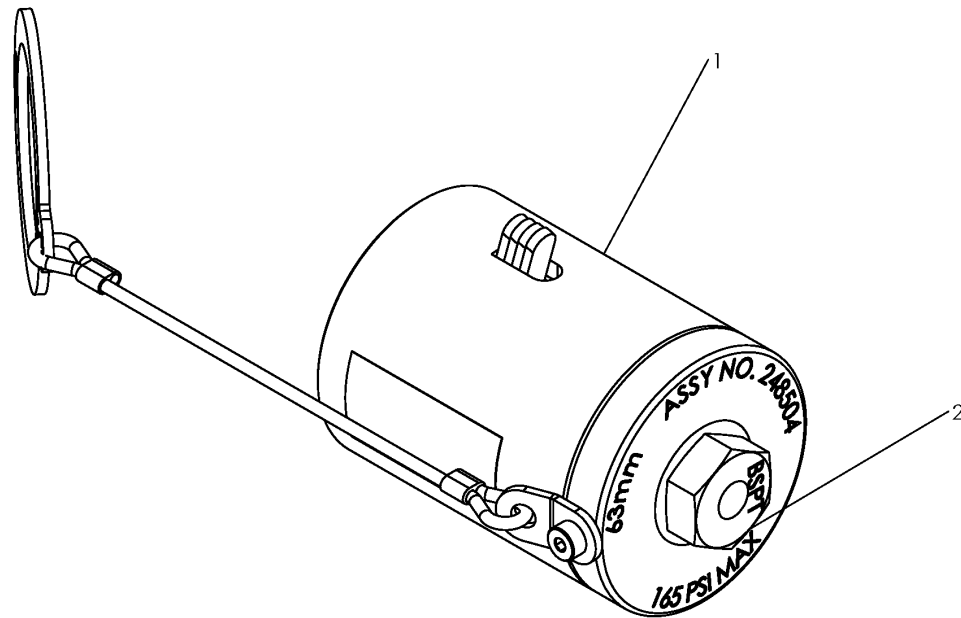

McElroy Manufacturing Parts List

Part Number: TP-1303 50mm Test Cap Assembly

Part Number TP-1303 Component List

Item	Component	Description	Quantity	Unit	Price
1	248503	50mm Hot Tap Tool Housing Assembly	1.0	EA	241.00
2	MFA00274	12MSAE/4BSPT Adapter	1.0	EA	21.64
3	TP-901	Test Cap Operator's Manual	1.0	EA	0.00

Please visit <https://fusion.mcelroy.com/parts> to purchase parts or for more information.

