



McElroy Manufacturing, Inc.
 The leader by design.
 Tulsa, Oklahoma U.S.A.

DRAWN: TLW CHECK: JRP APPRV'D: B DATE: 8/3/96 SHT No: 2 REV No: G PART No: 821802

HEATER BAG ASSEMBLY

NOTE: THIS DRAWING AND THE INFORMATION CONTAINED THEREIN IS THE CONFIDENTIAL AND PROPRIETARY PROPERTY OF McElroy Manufacturing, Inc. THE DRAWING IS NOT TO BE REPRODUCED IN ANY MANNER, SUBMITTED OUTSIDE PARTIES FOR EXAMINATION, OR USED DIRECTLY OR INDIRECTLY FOR THE PURPOSES OTHER THAN THOSE FOR WHICH IT WAS FURNISHED WITHOUT WRITTEN PERMISSION OF McElroy Manufacturing, Inc.

NOTES:

1. CLOSE LOOP THIS HOOK ONLY.

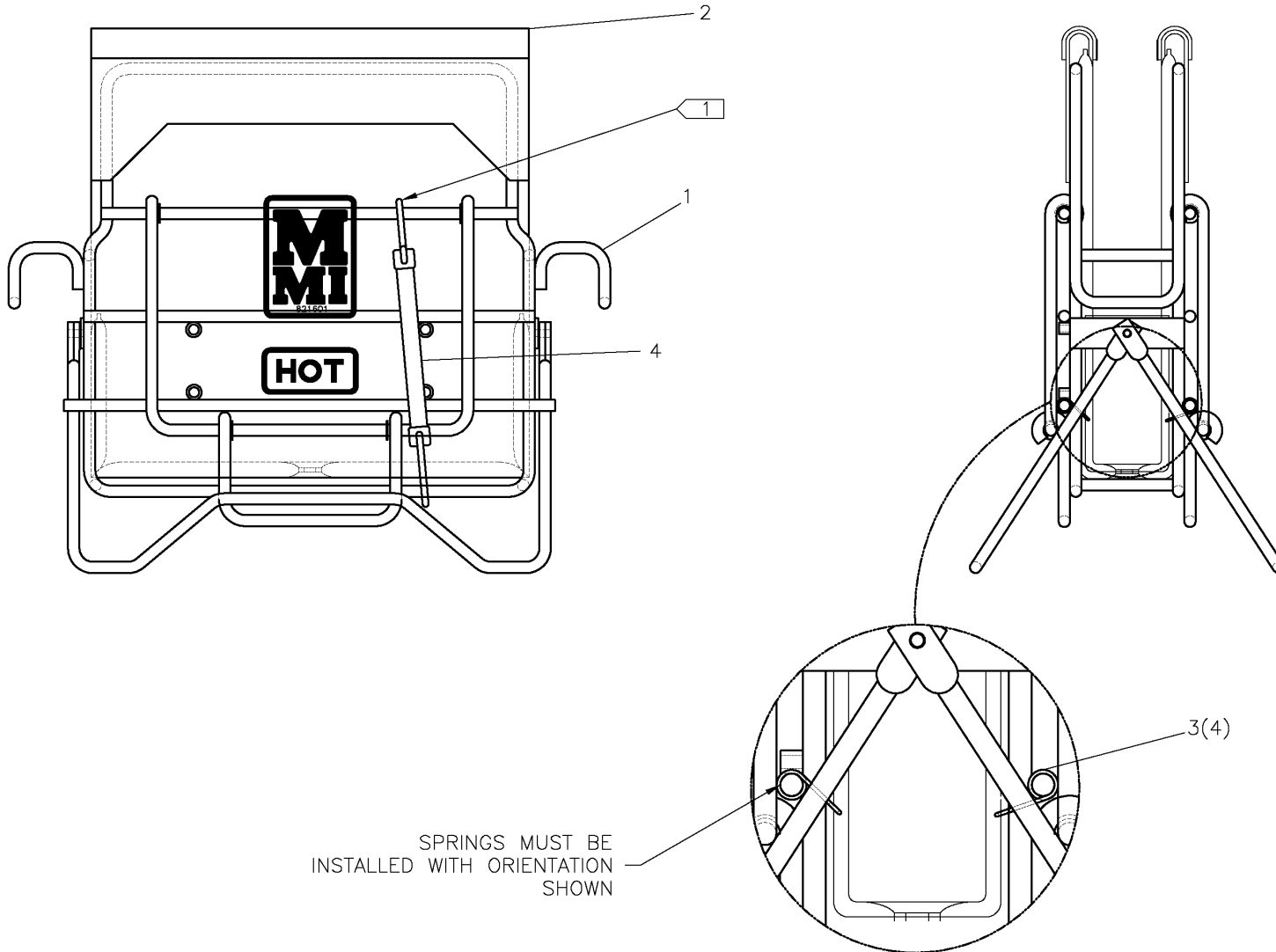

SPRINGS MUST BE
 INSTALLED WITH ORIENTATION
 SHOWN

McElroy Manufacturing Parts List

Part Number: 821802 Heater Bag Assembly

Part Number 821802 Component List

Item	Component	Description	Quantity	Unit	Price
1	821905	Heater Bag Frame Assy	1.0	EA	538.00
2	821601	Insulated Heater Bag	1.0	EA	430.00
3	1835208	Leg Retainer Spring	4.0	EA	3.72
4	MJG00001	10" Bungee Cord W/s-hook	1.0	EA	4.61

Please visit <https://fusion.mcelroy.com/parts> to purchase parts or for more information.

