



**McElroy Manufacturing, Inc.**  
 The leader by design.  
 Tulsa, Oklahoma U.S.A.

DRAWN: BWW	CHECK: MLM	APPRV'D: SRB	DATE: 11/19/04	DWG No: TP-300	SHT No: 1	REV No:	PART No: TABULATED
TEST CAP ASSEMBLY							CAD No: TP-300

NOTE: THIS DRAWING AND THE INFORMATION CONTAINED THEREIN IS THE CONFIDENTIAL AND PROPRIETARY PROPERTY OF McElroy Manufacturing, Inc. THE DRAWING IS NOT TO BE REPRODUCED IN ANY MANNER, SUBMITTED OUTSIDE PARTIES FOR EXAMINATION, OR USED DIRECTLY OR INDIRECTLY FOR THE PURPOSES OTHER THAN THOSE FOR WHICH IT WAS FURNISHED WITHOUT WRITTEN PERMISSION OF McElroy Manufacturing, Inc.

NOTES:  
 1. PARTS FOR 2" IPS ONLY.

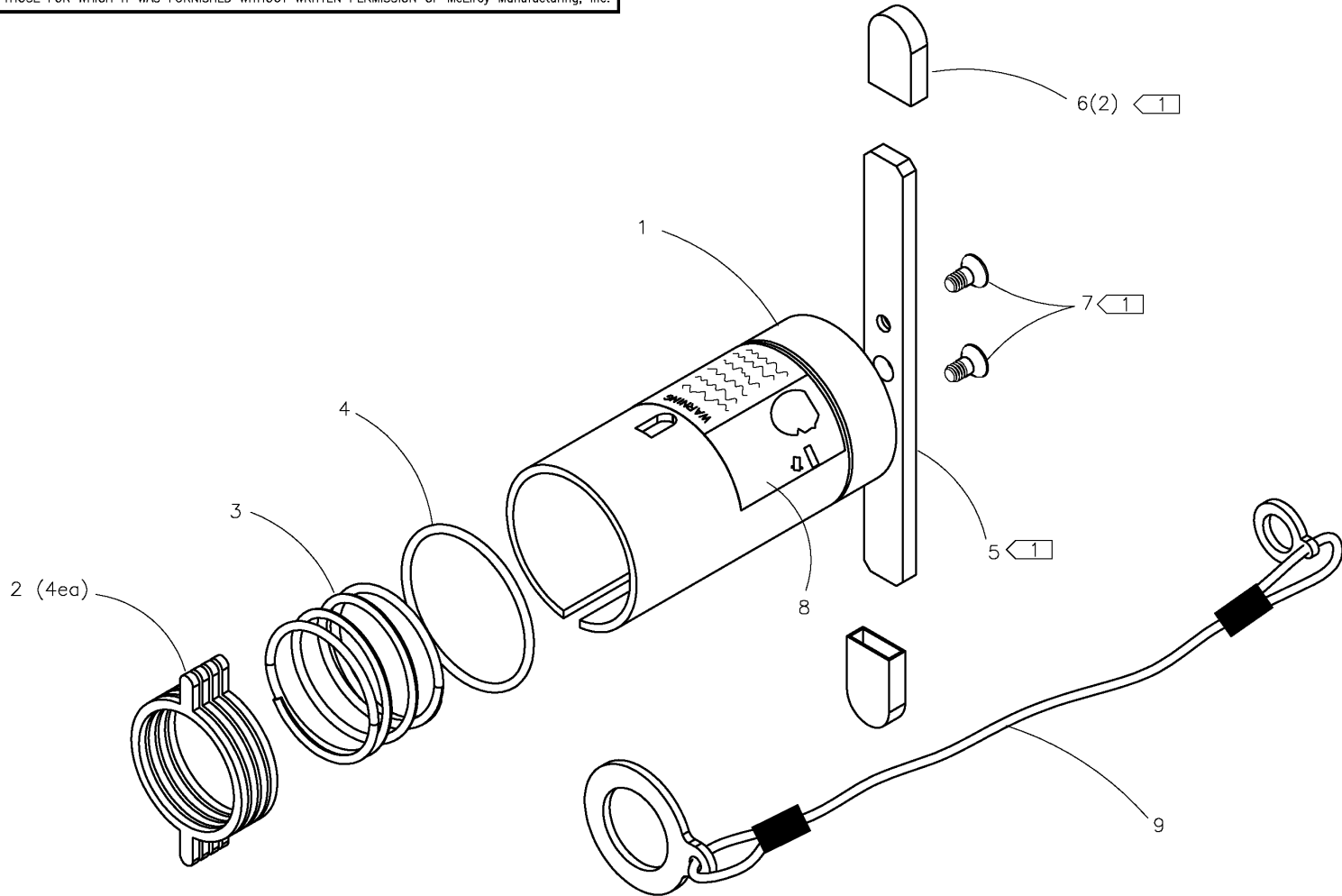

UNLESS NOTED OTHERWISE: (3) PLC. DIM'S .XXX = ±0.005" (2) PLC. DIM'S .XX = ±0.010" FRACTIONAL DIM'S = ±1/32" ANGULAR DIM'S = ±1/4" REMOVE ALL BURRS BREAK ALL SHARP EDGES STAMP OR ETCH P/N ON ALL DETAIL PARTS

MMI NUMBER	ITEM	QTY.	SIZE AND DESCRIPTION

## McElroy Manufacturing Parts List

**Part Number:** TP-308 1-1/4IPS Test Cap Assembly

### Part Number TP-308 Component List

Item	Component	Description	Quantity	Unit	Price
1	TP-408	1-1/4IPS Test Cap Housing	1.0	EA	0.00
2	TP-608	1-1/4IPS Test Cap Locking Ring	4.0	EA	16.27
3	TP-703	1-1/4-1-1/2IPS TC Comp Spring	1.0	EA	15.50
4	MDL00174	Buna-n 70 Duro O-ring	1.0	EA	0.92
8	TP-1201	Test Cap Warning Label	1.0	EA	9.29
9	TP-1108	1-1/4 IPS Test Cap Lanyard Assembly	1.0	EA	57.68

Please visit <https://fusion.mcelroy.com/parts> to purchase parts or for more information.

