



McElroy Manufacturing, Inc.
The leader by design.
Tulsa, Oklahoma U.S.A.

DRAWN: TGW CHECK: TLW APPRVD: SWB DATE: 11/18/98 SHT No: 7 REV No: H PART No: 220000

2" HOT TAPPING TOOL ASSEMBLIES

NOTE: THIS DRAWING AND THE INFORMATION CONTAINED THEREIN IS THE CONFIDENTIAL AND PROPRIETARY PROPERTY OF McElroy Manufacturing, Inc. THE DRAWING IS NOT TO BE REPRODUCED IN ANY MANNER, SUBMITTED TO OUTSIDE PARTIES FOR EXAMINATION, OR USED DIRECTLY OR INDIRECTLY FOR THE PURPOSES OTHER THAN THOSE FOR WHICH IT WAS FURNISHED WITHOUT WRITTEN PERMISSION OF McElroy Manufacturing, Inc.

NOTES:
1. ITEM 5 NOT SHOWN.
2. ITEM (220801 SLEEVE) IS OPTIONAL.

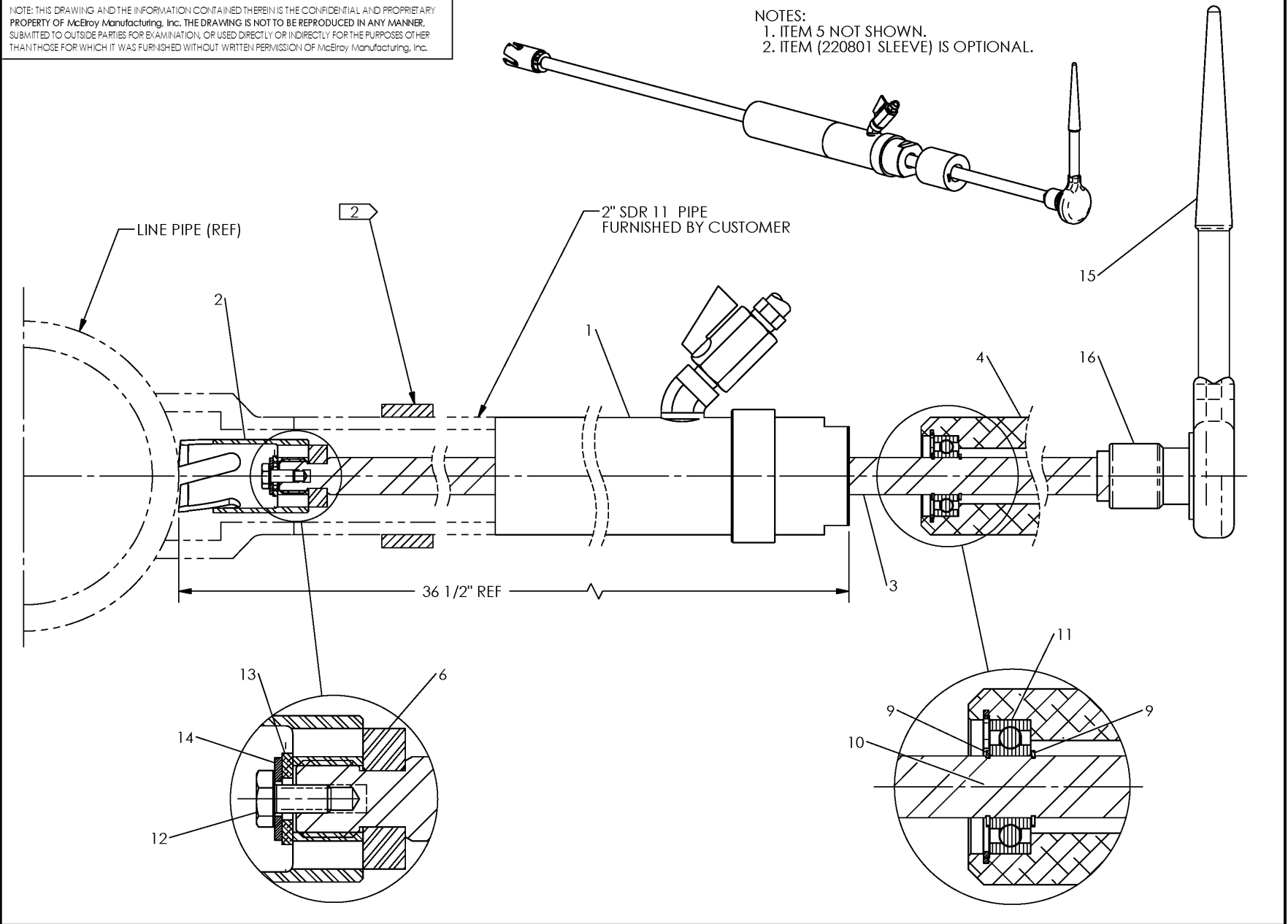

McElroy Manufacturing Parts List

Part Number: 220002 2IPS Medium Density 2406/2708 Hot Tapping Tool Assembly

Part Number 220002 Component List

Item	Component	Description	Quantity	Unit	Price
1	22120302	2IPS Medium Density 2406/2708 Hot Tapping Tool Gland Fitting Assembly	1.0	EA	1,249.00
2	221501	2-5/8L X 1-1/2D Toothed Cutter	1.0	EA	1,100.00
3	221301	2IPS Htt Shaft	1.0	EA	767.00
4	220701	Htt Bearing Housing	1.0	EA	213.00
5	226101	2,3&4 Htt Box W/foam Inserts (Effective 3/4/09 to 1/13/21)	1.0	EA	603.00
5	251601	Htt Box W/foam Inserts	1.0	EA	682.00
6	MJQ00056	1/2" Bore Clamp Collar	1.0	EA	52.76
9	MCB00003	Ext Snap Ring	2.0	EA	0.43
10	MCA00007	1.625 Int Snap Ring	1.0	EA	1.45
11	MDM00028	Ball Bearing	1.0	EA	43.79
12	MAH00091	1/4-20NCX1/2LG Hhcs	1.0	EA	1.11
13	MBG00025	3/8 Thrust Washer	1.0	EA	6.32
14	MBF00005	1/4 TY 'a' Wide FL Wshr Stil PL	1.0	EA	0.11
15	MJL00004	7/8 & 3/4 Ratchet Box Wrench (Effective 1/31/89 to 7/6/10)	1.0	EA	0.00
15	MJL00005	1/2 Drive Ratchet Wrench	1.0	EA	240.00
16	MJL00006	7/8 Socket X 1/2 Drive	1.0	EA	39.31

Please visit <https://fusion.mcelroy.com/parts> to purchase parts or for more information.