



McElroy Manufacturing, Inc.
The leader by design.
Tulsa, Oklahoma U.S.A.

DRAWN: TLW CHECK: BWP APPRV'D: B DATE: 6/01/95 DWG No: 220300 SHT No: 5 REV No: B PART No: 220305

6" HOT TAPPING TOOL POLYVALVE CONVERSION KIT CAD No: 220305

NOTE: THIS DRAWING AND THE INFORMATION CONTAINED THEREIN IS THE CONFIDENTIAL AND PROPRIETARY PROPERTY OF McElroy Manufacturing, Inc. THE DRAWING IS NOT TO BE REPRODUCED IN ANY MANNER, SUBMITTED OUTSIDE PARTIES FOR EXAMINATION, OR USED DIRECTLY OR INDIRECTLY FOR THE PURPOSES OTHER THAN THOSE FOR WHICH IT WAS FURNISHED WITHOUT WRITTEN PERMISSION OF McElroy Manufacturing, Inc.

NOTES:

1. THIS KIT IS USED TO CONVERT A STANDARD 6" HOT TAPPING TOOL TO A 6" POLYVALVE HOT TAPPING TOOL.

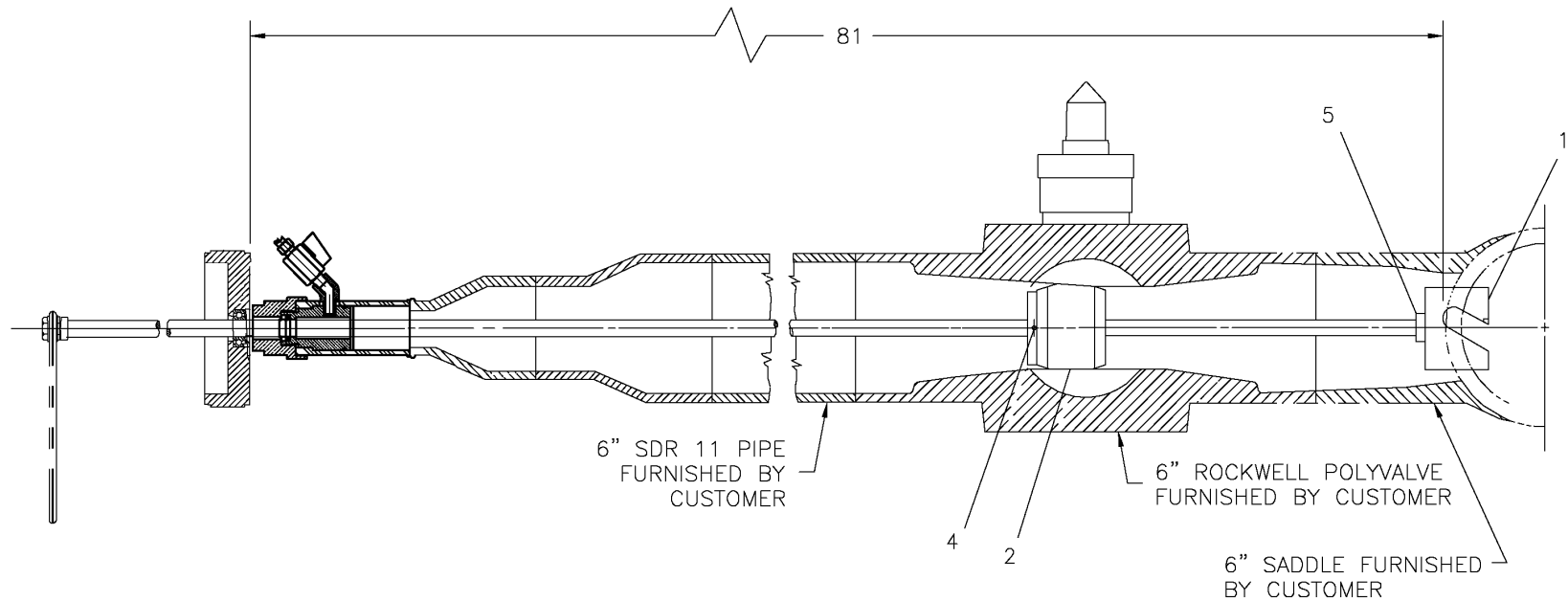

McElroy Manufacturing Parts List

Part Number: 220305 6IPS Hot Tapping Tool Polyvalve Conversion Kit

Part Number 220305 Component List

Item	Component	Description	Quantity	Unit	Price
1	221702	3-3/8L X 3D Toothed Cutter	1.0	EA	1,100.00
2	222201	6IPS Htt Cutter Guide	1.0	EA	0.00
3	222302	6IPS Htt Rest Button Ext	2.0	EA	0.00
4	MCG00006	3/16DIA X 1-1/4LG Roll Pin	1.0	EA	0.32
5	MJQ00056	1/2" Bore Clamp Collar	1.0	EA	52.76

Please visit <https://fusion.mcelroy.com/parts> to purchase parts or for more information.

