



McElroy Manufacturing, Inc.
The leader by design.
Tulsa, Oklahoma U.S.A.

DRAWN: MRH	CHECK: SPA	APPRVD: PJD	DATE: 3/7/18	SHT No: 1	REV No: A	PART No: 2480400
------------	------------	-------------	--------------	-----------	-----------	------------------

Acrobat™ W/QuikFit™ OUTER FIXED JAW ASSEMBLY

NOTE: THIS DRAWING AND THE INFORMATION CONTAINED THEREIN IS THE CONFIDENTIAL AND PROPRIETARY PROPERTY OF McElroy Manufacturing, Inc. THE DRAWING IS NOT TO BE REPRODUCED IN ANY MANNER, SUBMITTED TO OUTSIDE PARTIES FOR EXAMINATION, OR USED DIRECTLY OR INDIRECTLY FOR THE PURPOSES OTHER THAN THOSE FOR WHICH IT WAS FURNISHED WITHOUT WRITTEN PERMISSION OF McElroy Manufacturing, Inc.

NOTES:

1. PINS TO BE INSERTED FLUSH OR BELOW THE SURFACE OF BOTH SIDES OF THE JAW.
2. APPLY MEDIUM STRENGTH THREAD LOCKER.

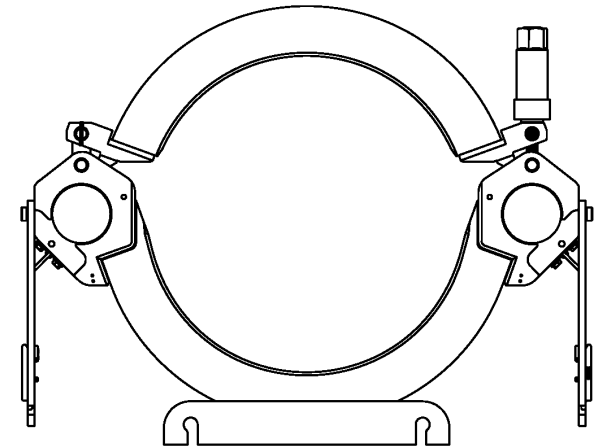
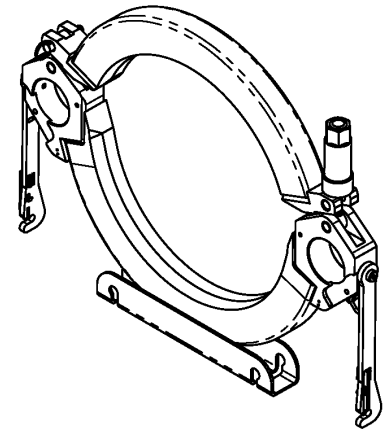
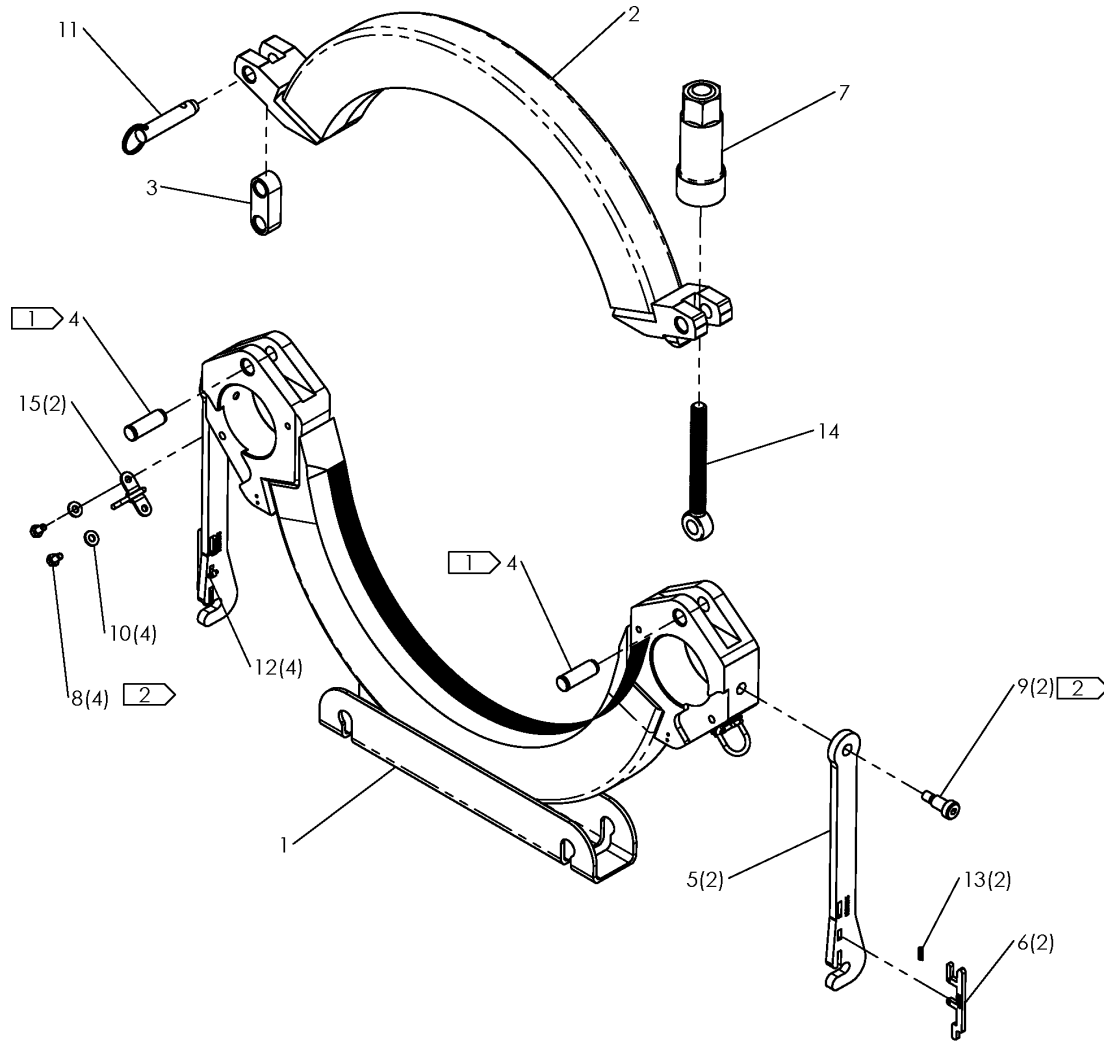

PINS UP ORIENTATION

McElroy Manufacturing Parts List

Part Number: 2480404 Acrobat w/ QuikFit 500mm Outer Fixed Jaw Assembly

Part Number 2480404 Component List

Item	Component	Description	Quantity	Unit	Price
1	2485104	500MM Lower Fixed Jaw	1.0	EA	0.00
2	2485604	500MM Upper Jaw	1.0	EA	0.00
3	2486401	Pivot Link	1.0	EA	92.29
4	2486402	.623"X1-7/8" Knurled Pivot Pin	2.0	EA	54.10
5	2486501	Jaw Brace	2.0	EA	180.00
6	2486502	Slide Latch	2.0	EA	62.66
7	A1226203	Clamp Knob Assembly	1.0	EA	177.00
8	MAB00002	1/4-20NCX1/2LG Hhcs	4.0	EA	0.18
9	MAF00043	1/2DIA X3/4LG Skt HD Shldr Scr	2.0	EA	6.25
10	MBF00005	1/4 TY 'a' Wide FL Wshr Stl PL	4.0	EA	0.11
11	MCE00062	5/8DIA X2.00 Grip Detent Pin	1.0	EA	11.69
12	MCG00003	1/8DIA X1/2LG Roll Pin	4.0	EA	0.27
13	MJE00062	3/16 Dia Compression Spring	2.0	EA	9.30
14	MJB00023	5/8-11X6LG Eye Bolt	1.0	EA	32.97
15	MJD00078	1" X 800LB Mntg Ring SS	2.0	EA	0.00

Please visit <https://fusion.mcelroy.com/parts> to purchase parts or for more information.