



McElroy Manufacturing, Inc.
The leader by design.
Tulsa, Oklahoma U.S.A.

DRAWN: MRH CHECK: SPA APPRVD: PJD DATE: 3/7/18 SHT No: 1 REV No: PART No: 2480900

Acrobat™ w/ QuikFit™ GUIDE ROD SUPPORT ASSEMBLY

NOTE: THIS DRAWING AND THE INFORMATION CONTAINED THEREIN IS THE CONFIDENTIAL AND PROPRIETARY PROPERTY OF McElroy Manufacturing, Inc. THE DRAWING IS NOT TO BE REPRODUCED IN ANY MANNER, SUBMITTED TO OUTSIDE PARTIES FOR EXAMINATION, OR USED DIRECTLY OR INDIRECTLY FOR THE PURPOSES OTHER THAN THOSE FOR WHICH IT WAS FURNISHED WITHOUT WRITTEN PERMISSION OF McElroy Manufacturing, Inc.

NOTES:

- 1. PINS TO BE INSERTED WITH LOCKING FEATURE IN THE JAW.
- 2. APPLY MEDIUM STRENGTH THREAD LOCKER.

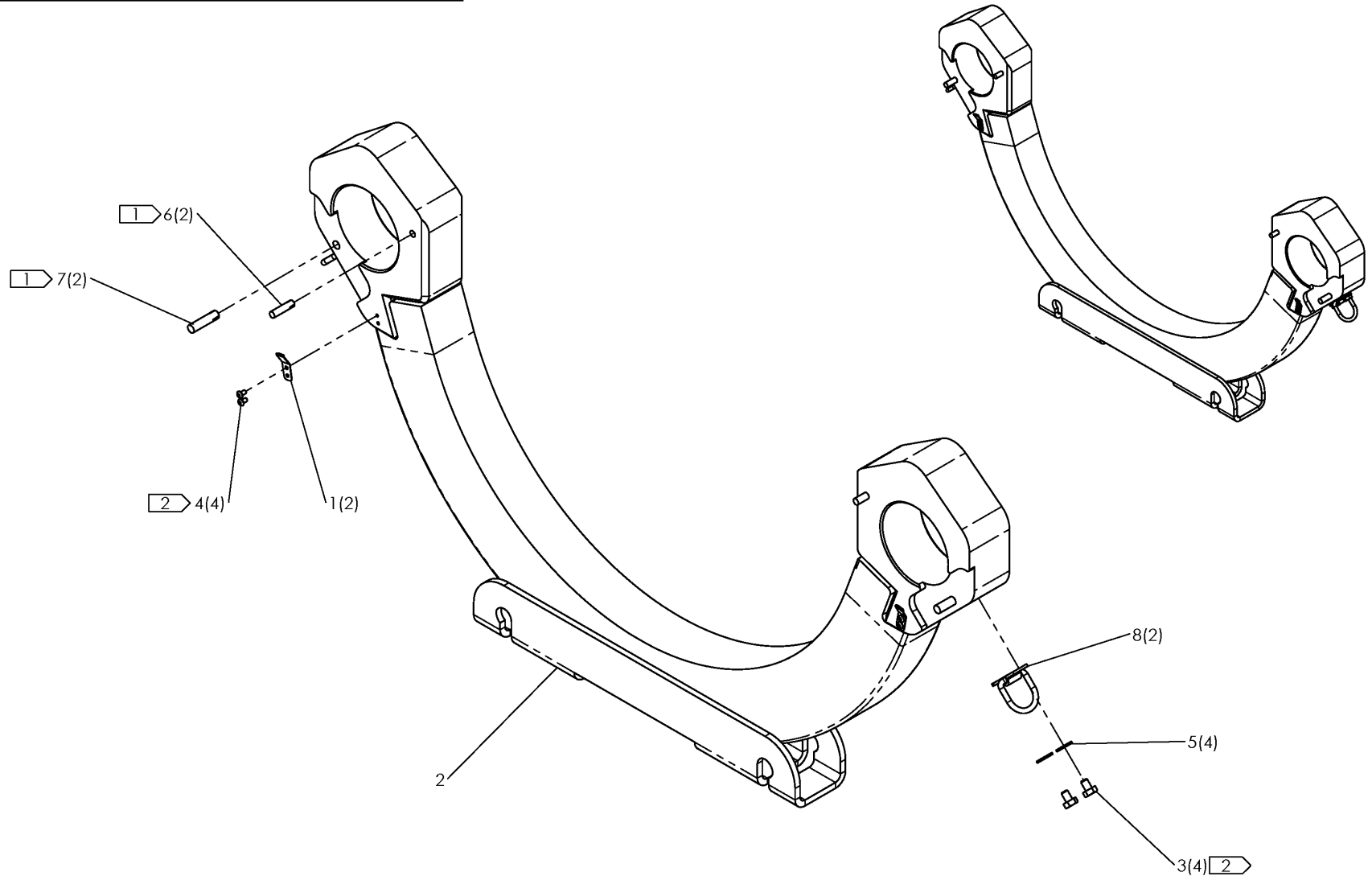

McElroy Manufacturing Parts List

Part Number: 2480904 Acrobat w/ QuikFit 500mm Guide Rod Support Assembly

Part Number 2480904 Component List

Item	Component	Description	Quantity	Unit	Price
1	2486007	Secondary Latch Clip	2.0	EA	25.91
2	2486104	500MM Guide Rod Support	1.0	EA	0.00
3	MAB00002	1/4-20NCX1/2LG Hhcs	4.0	EA	0.18
4	MAE00008	#6-32NCX1/4LG Bhscs PL	4.0	EA	0.29
5	MBF00005	1/4 TY 'a' Wide FL Wshr Stl PL	4.0	EA	0.11
6	MCK00121	1/4DIAX1LG Lck Pin Stl PL	2.0	EA	0.00
7	MCK00122	5/16DIAX1-1/4LG Lck Pin Stl PL	2.0	EA	0.00
8	MJD00078	1" X 800LB Mntg Ring SS	2.0	EA	0.00

Please visit <https://fusion.mcelroy.com/parts> to purchase parts or for more information.

