

DynaMc® 250 HP 4 JAW FUSION MACHINE PACKAGE

NOTE: THIS DRAWING AND THE INFORMATION CONTAINED THEREIN IS THE CONFIDENTIAL AND PROPRIETARY PROPERTY OF McElroy Manufacturing, Inc. THE DRAWING IS NOT TO BE REPRODUCED IN ANY MANNER, SUBMITTED TO OUTSIDE PARTIES FOR EXAMINATION, OR USED DIRECTLY OR INDIRECTLY FOR THE PURPOSES OTHER THAN THOSE FOR WHICH IT WAS FURNISHED WITHOUT WRITTEN PERMISSION OF McElroy Manufacturing, Inc.

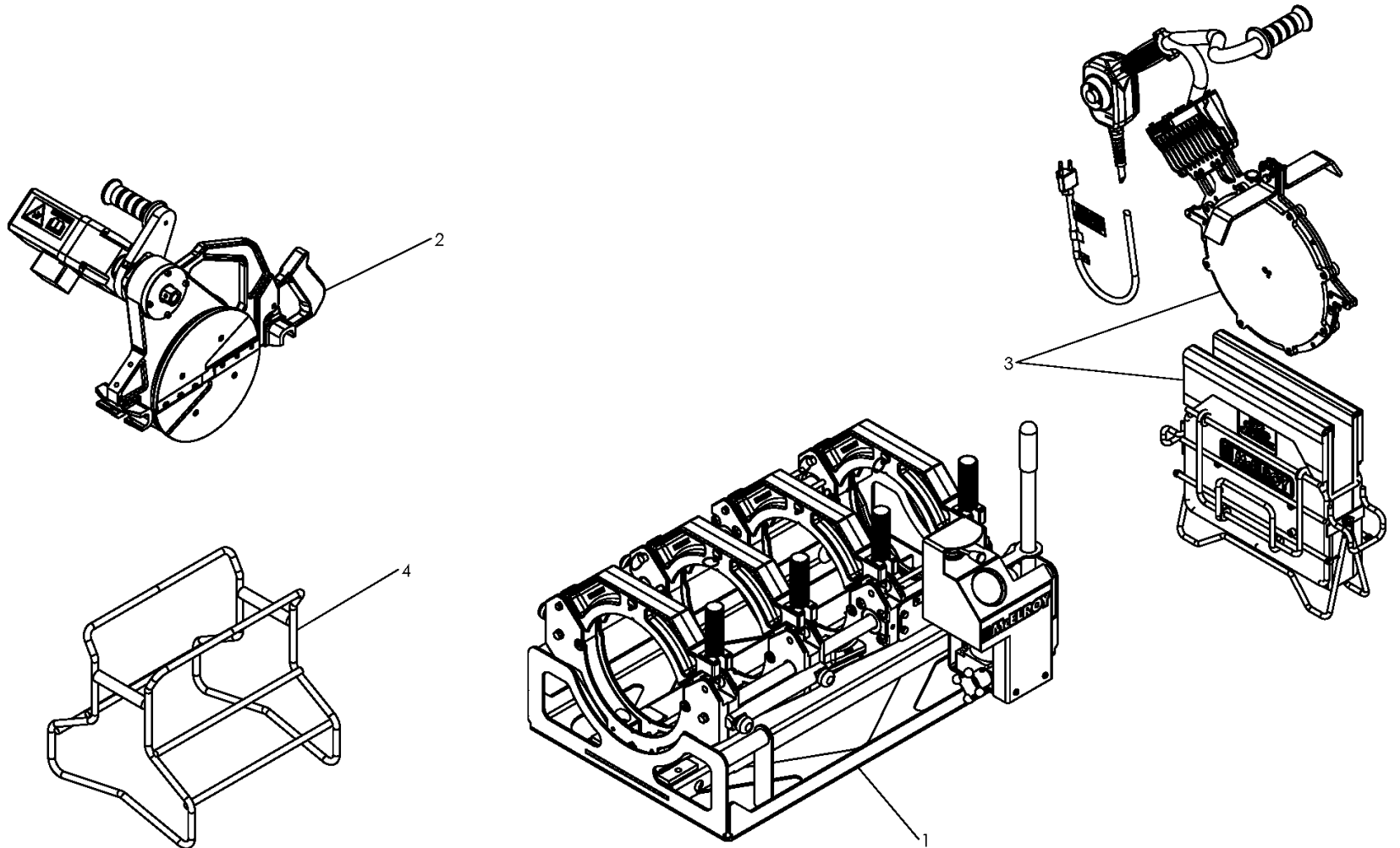

McElroy Manufacturing Parts List

Part Number: A882601 DynaMc 250 Hand Pump 4 Jaw 100V & 240V Fusion Machine Package

Part Number A882601 Component List

Item	Component	Description	Quantity	Unit	Price
1	881901	DynaMc 250 Hand Pump Carriage Assembly	1.0	EA	16,831.00
2	882901	DynaMc 250 Hand Pump 100/120V, 50/60Hz, 1Ph Facer Assembly (Effective to 12/22/09)	1.0	EA	0.00
2	900801	DynaMc 250 Hand Pump 100-120V, 50/60Hz, 1Ph Facer Assembly	1.0	EA	6,746.00
3	T2501002	Obsolete & Replaced by T2515901 (Effective to 7/5/20)	1.0	EA	0.00
3	T2515901	250mm 240V Heater Assembly	1.0	EA	5,427.00
4	T801101	Facer Stand	1.0	EA	500.00

Please visit <https://fusion.mcelroy.com/parts> to purchase parts or for more information.

