



McElroy Manufacturing, Inc.
 The leader by design.
 Tulsa, Oklahoma U.S.A.

DRAWN: BWW	CHECK: MLM	APPRV'D: SRB	DATE: 11/19/04	DWG No: TP-300	SHT No: 1	REV No:	PART No: TABULATED
TEST CAP ASSEMBLY							CAD No: TP-300

NOTE: THIS DRAWING AND THE INFORMATION CONTAINED THEREIN IS THE CONFIDENTIAL AND PROPRIETARY PROPERTY OF McElroy Manufacturing, Inc. THE DRAWING IS NOT TO BE REPRODUCED IN ANY MANNER, SUBMITTED OUTSIDE PARTIES FOR EXAMINATION, OR USED DIRECTLY OR INDIRECTLY FOR THE PURPOSES OTHER THAN THOSE FOR WHICH IT WAS FURNISHED WITHOUT WRITTEN PERMISSION OF McElroy Manufacturing, Inc.

NOTES:
 1. PARTS FOR 2" IPS ONLY.

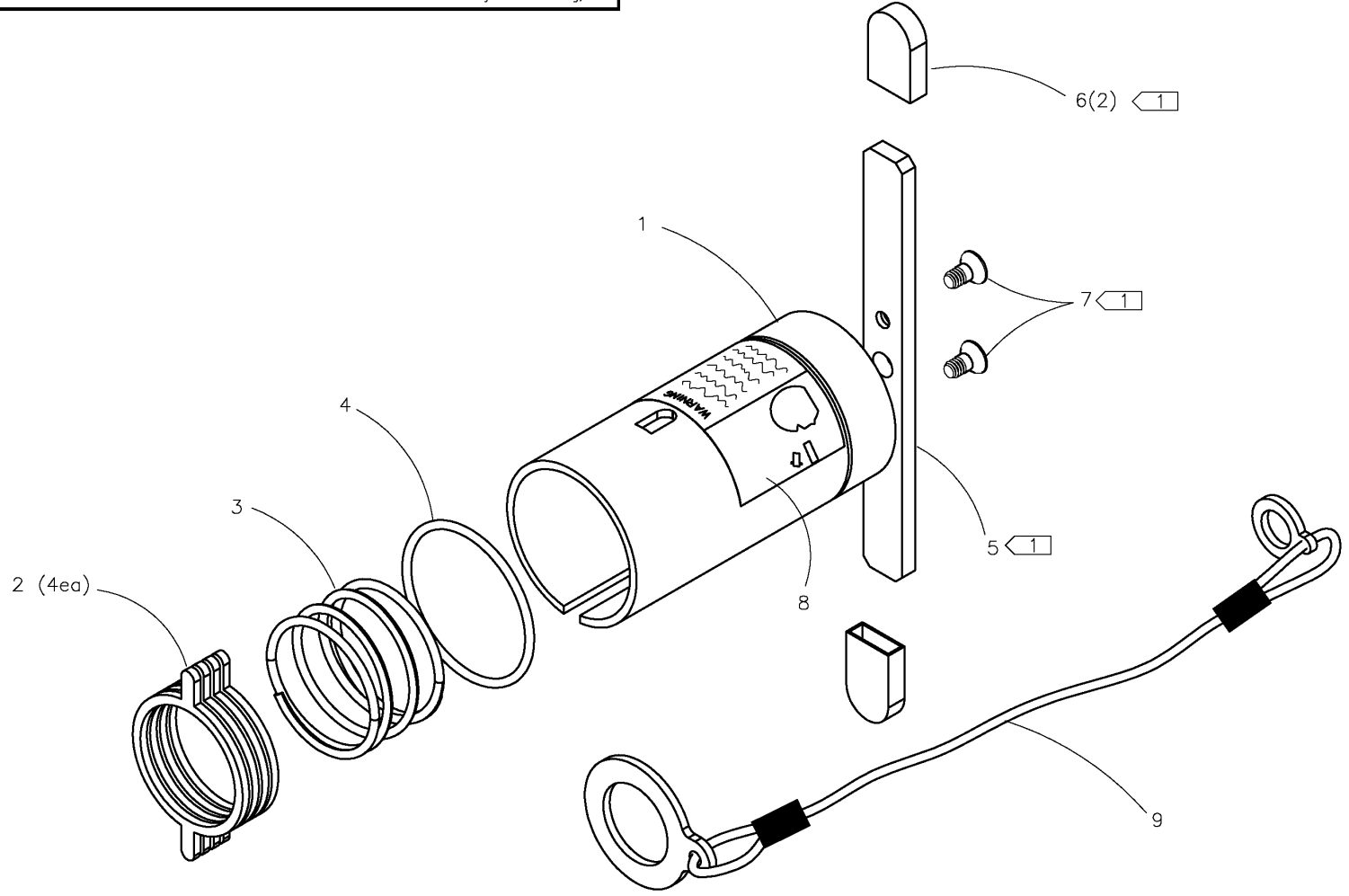

UNLESS NOTED OTHERWISE: (3) PLC. DIM'S .XXX = ±0.005" (2) PLC. DIM'S .XX = ±0.010" FRACTIONAL DIM'S = ±1/32" ANGULAR DIM'S = ±1/4" REMOVE ALL BURRS BREAK ALL SHARP EDGES STAMP OR ETCH P/N ON ALL DETAIL PARTS

MMI NUMBER	ITEM	QTY.	SIZE AND DESCRIPTION



McElroy Manufacturing Parts List

Part Number: TP-301 1/2CTS Test Cap Assembly

Part Number TP-301 Component List

Item	Component	Description	Quantity	Unit	Price
1	TP-401	1/2CTS Test Cap Housing	1.0	EA	0.00
2	TP-601	1/2CTS Test Cap Locking Ring	4.0	EA	12.61
3	TP-701	1/2CTS-3/4IPS TC Comp Spring	1.0	EA	18.81
4	MDL00131	O-ring	1.0	EA	0.85
8	TP-1201	Test Cap Warning Label	1.0	EA	8.25
9	TP-1101	1/2 CTS Test Cap Lanyard Assembly	1.0	EA	83.79

Please visit <https://fusion.mcelroy.com/parts> to purchase parts or for more information.

